	<b>Movement Specification</b>	
	<b>Caliber 284</b>	<b>Date 26.06.2020</b>
	<b>Version 1.0</b>	<b>Approval P. Fraboulet</b>
	<b>Reference: Movement Spec MOMT284</b>	<b>Page 1 / 8</b>

Caliber 284

MOMT284

Rechargeable Connected Movement with  
HRM and Color Touch Screen

	<b>Movement Specification</b>	
	Caliber 284	Date 26.06.2020
	Version 1.0	Approval P. Fraboulet
	Reference: Movement Spec MOMT284	Page 2 / 8

### **Product Specifications:**

Analog connected quartz movement with:

- High resolution color TOUCH screen (AMOLED)
- Medical grade Heart Rate Monitoring
- Rechargeable battery
- High sensitivity built-in GPS

Caliber	284
Movement Diameter	38.5 mm
Battery Life (Rechargeable)	8 days*
Hand Fitting	Height 1
Origin	Swiss Made
Jewels	0 (zero)

\*Normal use. An intense use of some functionalities may decrease the autonomy.

	<b>Movement Specification</b>	
	Caliber 284	Date 26.06.2020
	Version 1.0	Approval P. Fraboulet
	Reference: Movement Spec MOMT284	Page 3 / 8

## Technical Specifications:

Diameter	38.5 mm
Fitting	38.0 mm
Movement height	6.4 mm
Battery capacity	180 mAh
Battery voltage	3.7 V
Operating temperature	0-50°C
Maximum running deviation	±1.7sec/day
Step variability	±6°/month
Hands positioning accuracy	±3°
AMOLED Display	0.82 Inch
Display resolution	240 x 120 pixels
GPS Sensitivity	-166 dBm

	<b>Movement Specification</b>	
	Caliber 284	Date 26.06.2020
	Version 1.0	Approval P. Fraboulet
	Reference: Movement Spec MOMT284	Page 4 / 8

## Features:

Bluetooth Low Energy

High resolution color touch AMOLED display

Activity tracker (step counting, energy expenditure, VO2MAX, Fitness Index)

Sleep monitoring (sleep patterns, Deep-Light-REM-Awake)

Resting Rate, Respiration Rate, Fitness Index

Workout with built-in GPS and map display (numerous activity types)

Chronograph

Rechargeable battery

Vibration alerts

Notifications (calls, messages and all other applications)

Worldtimer

Smart alarms

Weather forecast

Hydration level follow-up

Cloud Backup and restore

	<b>Movement Specification</b>	
	<b>Caliber 284</b>	<b>Date 26.06.2020</b>
	<b>Version 1.0</b>	<b>Approval P. Fraboulet</b>
	<b>Reference: Movement Spec MOMT284</b>	<b>Page 5 / 8</b>

## 1. Movement drawing

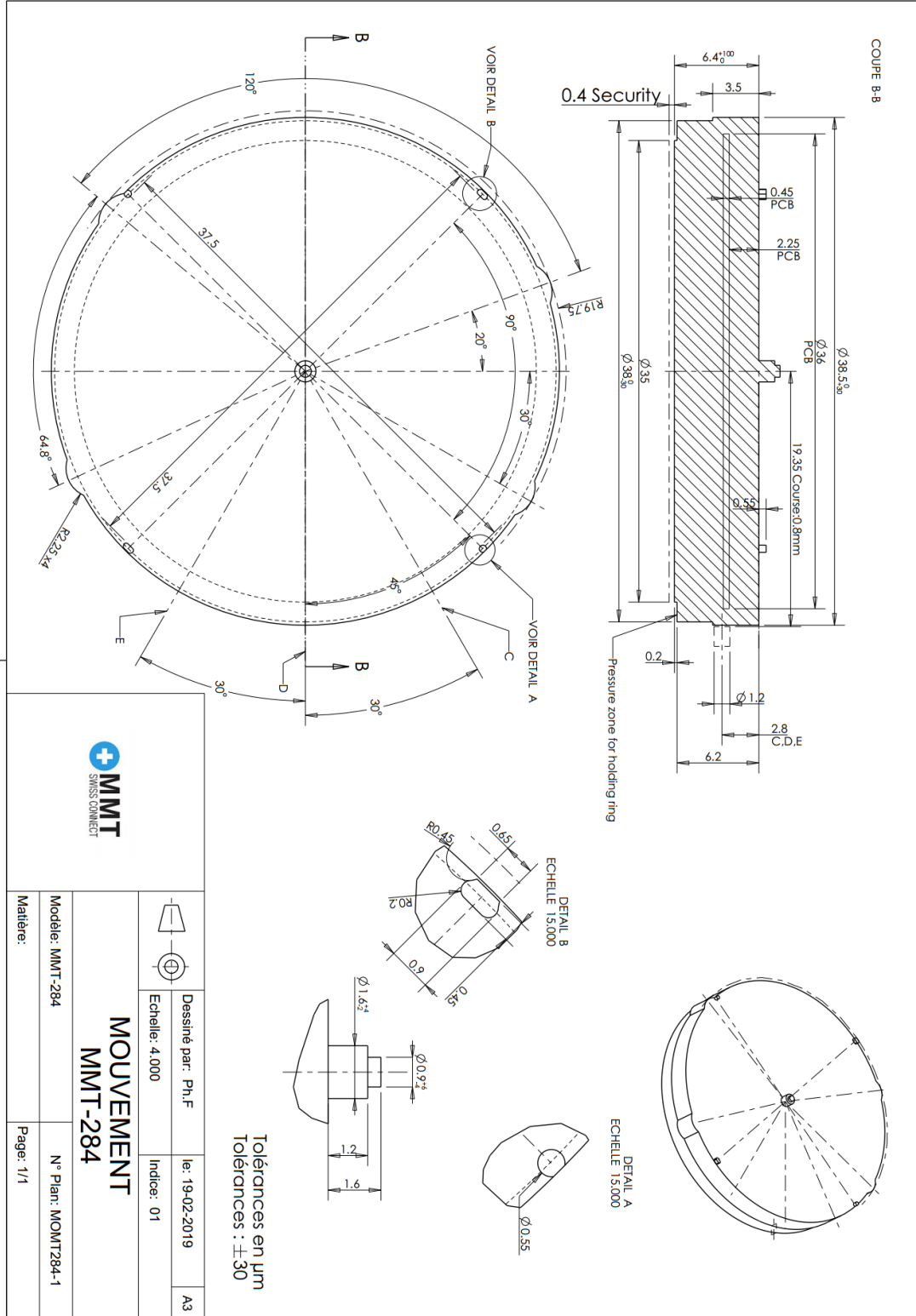

	<b>Movement Specification</b>	
	Caliber 284	Date 26.06.2020
	Version 1.0	Approval P. Fraboulet
	Reference: Movement Spec MOMT284	Page 6 / 8

## 2. Dial drawing

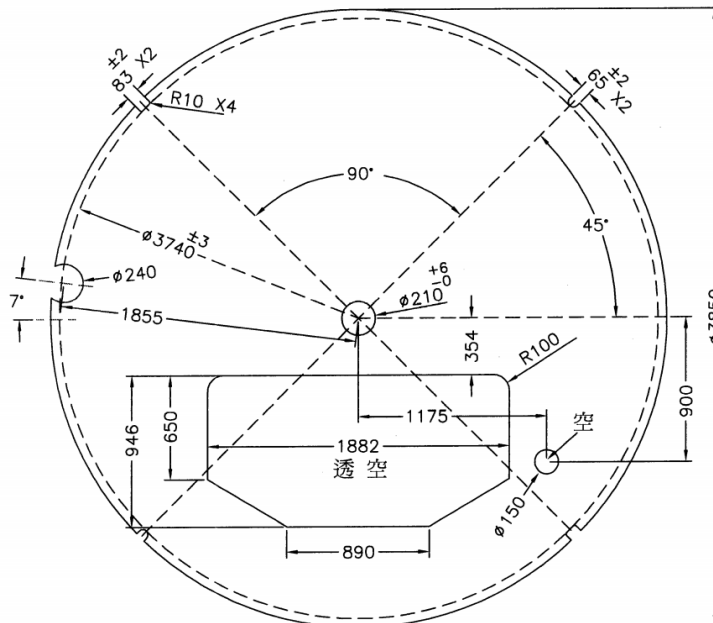
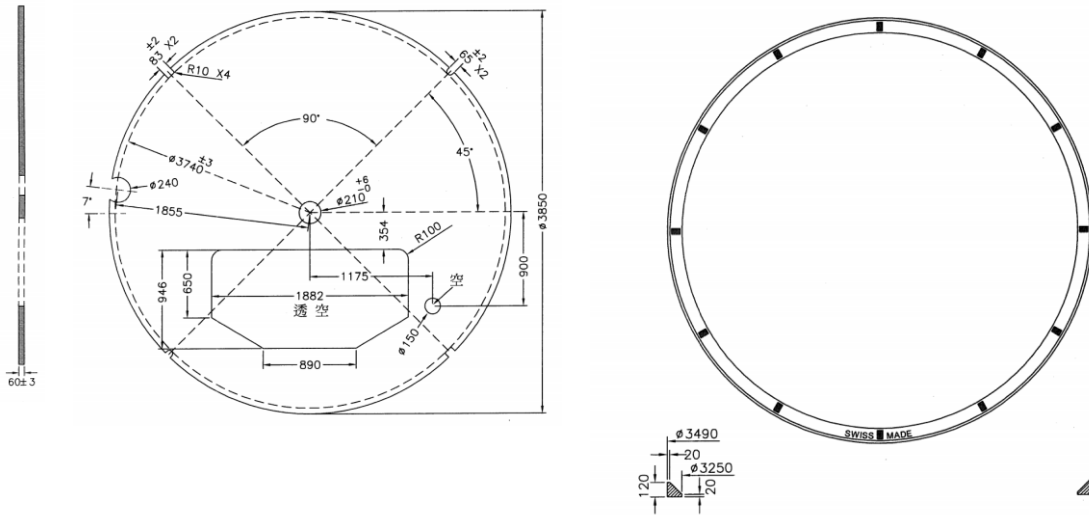





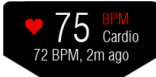

	<b>Movement Specification</b>	
	Caliber 284	Date 26.06.2020
	Version 1.0	Approval P. Fraboulet
	Reference: Movement Spec MOMT284	Page 7 / 8

### 3. Color Touch Display

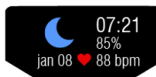
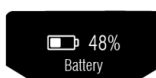
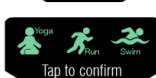
- Size 0.82 Inch
- Resolution: 120 RGB x 240

Here are examples of screens. They are subject to upgrades and changes.

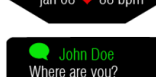
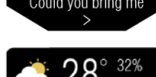
Main screen	
HRM	
Activity	
Sleep	
Battery level	
Workout selection	
GPS fix	
Chronograph	
Hydration	
Message notifications	
Weather forecast	

The touch functions for display navigation are:

1. Swipe Right
2. Swipe Left
3. Single Tap right
4. Single Tap left

	<b>Movement Specification</b>	
	<b>Caliber 284</b>	<b>Date 26.06.2020</b>
	<b>Version 1.0</b>	<b>Approval P. Fraboulet</b>
	<b>Reference: Movement Spec MOMT284</b>	<b>Page 8 / 8</b>

#### 4. Case back engravings

Due to regulations, there are mandatory engravings:

- Model number
- FCC/IC number
- Japan MIC number and logo
- Other particular engravings may be required